

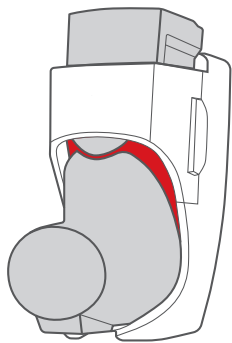

For use only with
Symbicort™/Vannair™
HFA/MDI

EN Product Manual



adherium



This Product Manual will help you to get the most out of your Hailie® sensor. Please read the manual before using the sensor.

Hailie® Sensor Intended Use
The Hailie® sensor is intended for single-patient use in the home environment as an electronic data capture accessory for monitoring and recording actuations, inspiratory flow, and inhaler shake, for prescribed inhaler usage.

The Hailie® sensor may be used in the following applications: in clinical practice or clinical trials, where specialists, general practitioners, nurses, and educators need to know

if a patient has used their prescribed medication, or assess inspiratory flow and inhaler technique; and in patient self-management including medication reminders.

The Hailie® sensor is compatible only with the **Symbicort™ MDI/Vannair™ HFA/MDI**.

The Hailie® sensor is not intended to indicate remaining quantity of medication in an inhaler and does not include a dose counting function. The Hailie® sensor is not intended to provide spirometry measurements.

Important User Information

- ⚠ Warnings** identify actions or situations that could lead to personal injury. Take note of all warnings before using the Hailie® sensor.
- ⚠ Precautions** identify actions or situations that could damage the Hailie® sensor or other equipment, or affect the accuracy or availability of recorded usage data.
- 📄 Notes** contain advisory information about some aspect of the Hailie® sensor or its use.

Warnings and Precautions

- ⚠** To ensure your Inhaler functions correctly, do not use the Hailie® sensor with any other Inhaler or medication than that indicated on the Hailie® sensor label.
- ⚠** Refer to the labelling provided with the Inhaler for instructions on use. Carry out all steps required to use your Inhaler according to the instructions.
- ⚠** The Hailie® sensor is intended to track medication usage. It is not intended to diagnose your condition or to replace the diagnosis of a licensed physician.

⚠ This manual does not provide information on how to use prescription medication, and is not intended to replace the advice provided by a health professional. Directions for using prescription medication should be obtained from a health professional and followed accordingly. Any questions related to prescription medication should be referred to a health professional.

⚠ The Hailie® sensor does not contain a dose counter. Do not use data collected by the Hailie® sensor to determine the number of doses remaining in a medication canister.

⚠ If your prescribed Inhaler changes, do not use it with this Hailie® sensor. Only use a Hailie® sensor that is labelled as compatible with your prescribed Inhaler.

⚠ Keep the Hailie® sensor outside MRI scanner rooms.

⚠ Setup and use of the Hailie® sensor for patients under 12 years of age requires assistance from a parent or caregiver.

⚠ The Hailie® sensor is a battery-powered electronic device. Take care to not spill liquids on the Hailie® sensor or immerse it in water. Do not use the Hailie® sensor if it is not in good condition.

⚠ Do not expose the Hailie® sensor to excessive perspiration during exercise.

⚠ For hygiene and data integrity reasons, do not use the Hailie® sensor with more than one patient.

⚠ Remove the Hailie® sensor from the Inhaler before cleaning the Inhaler.

What is the Hailie® Sensor?
The Hailie® sensor is a companion tool that tracks your prescribed medication use and reminds you when to take your prescribed medication.

The Hailie® sensor is a small battery-powered electronic data logger that attaches to an Inhaler. The Hailie® sensor contains an electronic clock and calendar that is used to log the date and time of Inhaler usage. Usage data can be uploaded via a wireless *Bluetooth®* connection.

The Hailie® sensor has a built-in audiovisual alert to remind you when to take your prescribed medication — and tracks when you did — so you can have confidence you're following your prescription.

The Hailie® sensor records parameters of inhaler use, including inspiratory flow and shaking the inhaler before use, which may be used by your doctor to help assess your inhaler usage.

Hailie® Sensor Components

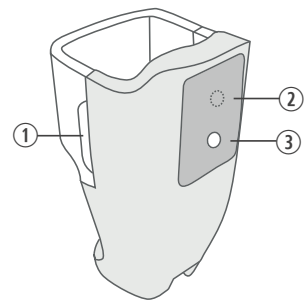

1. Door Latch
2. Light Emitting Diode (LED)
3. Status Button

Compatible Inhalers
The Hailie® sensor is designed to work only with the Inhaler and medication indicated on the Hailie® sensor label.

Country	Medication	Strength
AU	Symbicort™ Rapihaler™	50/3, 100/6, 200/6 mcg
UK	Symbicort™ MDI	200/6 mcg
US	Symbicort™ HFA	80/4.5, 160/4.5 mcg
NZ	Vannair™ MDI	100/6, 200/6 mcg

The Hailie® sensor intended population is identical to the intended population of the compatible Inhaler.

Preparation for First Use

⚠ Setup and use of the Hailie® sensor for patients under 12 years of age requires assistance from a parent or caregiver.

Following manufacture, the Hailie® sensor is placed in Deep-Sleep mode to conserve battery life.

The Hailie® sensor must be paired with a compatible *Bluetooth®* mobile device in order to sync stored usage data.

Download a compatible mobile app to communicate with your sensor. For more information go to support.hailie.com.

Ensure *Bluetooth®* is enabled on your mobile device.

1. Open the compatible mobile app.
2. Wake up the Hailie® sensor by pressing the Status Button.
3. The Hailie® sensor will wake up and the LED will flash green.
4. After 5 seconds the Hailie® sensor will automatically enter *Bluetooth®* pairing mode and the LED will flash blue for 60 seconds.
5. Follow the prompts to complete the pairing process.

6. The LED will flash green to indicate successful pairing.

☑ If pairing is not successful within 60 seconds the LED will flash red. The pairing process can be repeated if necessary by pressing the Status Button 3 times quickly to initiate pairing.

☑ The Hailie® sensor can only be paired with a single mobile device at one time. Successful pairing with a new mobile device will remove the current pairing. If pairing on the new mobile device fails, the existing pairing will be retained.

☑ The Hailie® sensor will re-enter Deep-Sleep mode within 24 hours if no activity occurs.

Installing and Removing an Inhaler

Installation

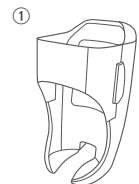

To install the Inhaler hold the Hailie® sensor in an upright position.

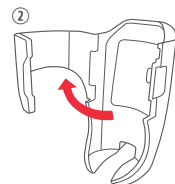

Open the door of the Hailie® sensor by pulling the Door Latch.

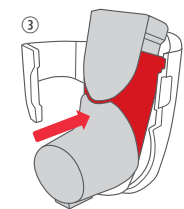

Push the Inhaler into the Hailie® sensor.

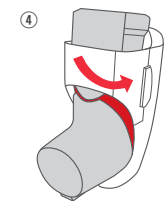

Close the door so it clicks into place.

⚠ The Hailie® sensor will not monitor inhaler use for 7 seconds after the inhaler is installed into the sensor.

Removal

⚠ To ensure medication usage is detected, wait for 3 seconds after medication usage before removing the inhaler from the Hailie® sensor.

1. To remove the Inhaler hold the Hailie® sensor in an upright position.
2. Pull the Door Latch to open the door of the Hailie® sensor.
3. Pull the Inhaler to remove it from the Hailie® sensor.
4. Close the door so it clicks into place.

Delivering a Dose of Medication

⚠ Refer to the labelling provided with the Inhaler for instructions on use. Carry out all steps required to use your Inhaler according to the instructions.

To use the Hailie® sensor, hold the Hailie® sensor in one hand with the thumb under the base of the Hailie® sensor and the index finger and second finger on top of the medication canister.

The Hailie® sensor LED flashes green, orange or red (to indicate battery level) 3 seconds after detecting the medication usage.

If the LED flashes red or if there is no flash, the Hailie® sensor is not monitoring usage. Check the battery level according to *Reviewing the Battery Level*.

⚠ This manual does not provide information on how to use prescription medication, and is not intended to replace the advice provided by a health professional. Directions for using prescription medication should be obtained from a health professional and followed accordingly. Any questions related to prescription medication should be referred to a health professional.

☑ The Hailie® sensor does not detect or record the quantity of medication delivered by the Inhaler.

To use the Hailie® sensor with a spacer, hold the Hailie® sensor in one hand with the thumb at the base of the Hailie® sensor and the index finger and second finger on top of the medication canister. Use the other hand to support the spacer chamber.

If necessary, you may require assistance from another person to hold the spacer chamber for you.

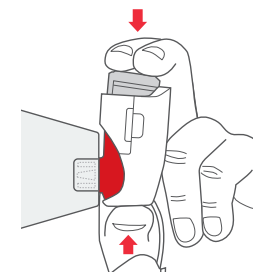

Medication Reminders

Audiovisual reminders may be set up from a compatible mobile app. If enabled, the medication reminders are generated on the Hailie® sensor with increasing frequency for up to 24 minutes, until either the prescribed medication dose is taken or the reminder is cancelled. The LED flashes green and the Hailie® sensor emits a beeping sound when the reminder alert is triggered.

To cancel the reminder, hold down the Status Button until you hear a beeping sound and the LED flashes red.

Reviewing Inhaler Usage Data

The Inhaler usage history can be automatically uploaded via a compatible paired mobile device.

The upload of new information will occur automatically as long as the Hailie® sensor is within range (10 meters or 32 feet) of the mobile device with *Bluetooth®* enabled.

☑ When travelling ensure your mobile device is set to the local time zone for accuracy of Inhaler usage data.

Manually Uploading Stored Information

The Hailie® sensor can manually upload data to a paired *Bluetooth®* mobile device.

- Hold down the Status Button until the LED shows white, then release.
- The LED will flash white while the Hailie® sensor attempts to upload, then flash green if the upload is successful.

The Hailie® sensor LED will flash red if the upload is not successful. Check the Hailie® sensor is within range of the paired mobile device and ensure that *Bluetooth®* communications are enabled.

Reviewing the Battery Level

The LED on the Hailie® sensor indicates the battery level after detecting medication usage, or when the Status Button is pressed once.

LED Colour	Battery Status
Green	The battery level is good. The Hailie® sensor is monitoring inhaler usage.
Orange	The battery level is low. The Hailie® sensor is still monitoring inhaler usage.
Red	The battery is depleted. The Hailie® sensor has stopped monitoring inhaler usage.
No Flash	The battery is depleted, or the Hailie® sensor has failed, e.g. due to liquid immersion or mechanical stress.

The battery is not rechargeable. Once depleted, a new Hailie® sensor will be required.

Cleaning the Hailie® Sensor and Inhaler

Check the instructions from the Inhaler manufacturer for keeping the inhaler and mouthpiece clean.

Remove the Hailie® sensor from the inhaler before cleaning the inhaler.

Keep the Hailie® sensor clean and free of chemicals, steam, water and dust. Clean the outside plastic enclosure with a lightly dampened cloth. Check the Hailie® sensor is clean and repeat if necessary. Leave it to dry in a warm place that is less than 30°C (86°F).

The Hailie® sensor is a battery-powered electronic device. Do not immerse the Hailie® sensor in water. Do not use the Hailie® sensor if it is not in good condition.

The cleaning method is intended to support single patient use. If the sensor is contaminated by another individual, it is recommended that the Hailie® sensor be discarded and replaced with a new sensor.

Storage

To help maintain battery capacity, store your Hailie® sensor below 30°C (86° F). Keep out of direct sunlight and avoid extreme temperatures.

The inhaler medication has its own storage recommendations. Refer to the labelling provided with the inhaler medication.

Troubleshooting

If the Hailie® sensor is not responding to *Bluetooth®* communications, check the Hailie® sensor battery level as per *Reviewing the Battery Level* in this manual. Ensure *Bluetooth®* is enabled in your mobile device.

Other wireless communications equipment such as wireless home network devices, mobile phones,

cordless telephones and their base stations, walkie-talkies, and equipment such as contactless payment or anti-theft systems, can affect the Hailie® sensor, and should be kept at least 30cm (12in) away.

Increase the separation distance between the Hailie® sensor and any such devices if this could be causing problems.

If this does not help, contact the supplier or manufacturer for further assistance.

Customer Support

For support on this product, go to [support.hailie.com](https://www.hailie.com).

For information about your medical condition or your medication, contact your healthcare provider.

EU only: Any serious incident that has occurred in relation to the Hailie® sensor should be reported to Adherium and the health authority of the Member State where it occurred.

A copy of this product manual is available on www.hailie.com/collections/hailie-sensors

Servicing

Contact the supplier or manufacturer for Hailie® sensor servicing. Do not attempt to open or service the Hailie® sensor. Tampering with the Hailie® sensor voids the warranty.

Disposal

Dispose or recycle the Hailie® sensor in accordance with regulations for your country, as applicable for electronic devices containing a lithium coin cell battery. Ensure that the inhaler is removed from the Hailie® sensor prior to disposal.

EU only: Do not dispose of the Hailie® sensor as unsorted municipal waste. The Hailie® sensor must be recycled in accordance with Directives 2012/19/EU

and 2006/66/EC. To arrange for return or disposal of the Hailie® sensor contact the supplier.

Warranty

The Hailie® sensor includes a 12 month warranty against manufacturing defects from date of first use. This warranty may be voided under the following circumstances: damage to the Hailie® sensor including dropping, water damage resulting from condensation or immersion, tampering, attempts to service, or other forms of abuse.





The Hailie® sensor warranty expires 4 years from date of manufacture.







Specifications



Model number	NF0109
Usage Log Precision	1 second
Usage Log Capacity	5120 usage logs and sensor status records
Internal Clock Accuracy	± 1 hour after 12 months Note: the Hailie® sensor clock is updated every time data is uploaded to a compatible mobile app.
Compatible with	iOS or Android mobile devices. Go to support.hailie.com for more information.
Wireless Technology	<i>Bluetooth®</i> 4.0: 2.40 - 2.48 GHz, 1.0 mW Low Energy
Battery Type	Lithium Coin Cell, Non-rechargeable
Shelf Life	3 years
Service Life	1 year
Operating Temperature	0 to 40°C (32 to 104°F)



Storage Temperature	-20 to 60°C (-4 to 140°F)
Operating / Storage Humidity	15 to 90% RH (non-condensing) at water vapour pressure ≤ 50 hPa

Symbols

Product Use	
	Read manual before use
	Keep dry
	Non-rechargeable Sensor
	Temperature limit
	Humidity limitation

Product Details	
	Manufacturer: Adherium (NZ) Limited
	Serial Number
	Part Number
	Model Number
	Date of Manufacture
	Country of Manufacture

Regulatory Compliance	
	AU only: Regulatory compliance mark
	EU only: Medical Device

	EU only: Do not dispose Hailie® sensor as unsorted municipal waste
	NZ only: Regulatory compliance mark
	UK only: UK conformity mark

Electromagnetic Compatibility

The Hailie® sensor does not perform any clinical function where loss or degradation would result in unacceptable risk.

Emissions / Immunity Test and Standard	Compliance Level
Radiated EMI CISPR 11	Group 1 Class B
Electrostatic Discharge IEC 61000-4-2	± 8 kV contact, ± 2/4/8/15 kV air
Radiated RF EM Fields IEC 61000-4-3	10 V/m: 80 - 2700 MHz
Proximity fields from RF wireless communications equipment IEC 61000-4-3	9 V/m: 710, 745, 780, 5240, 5500, 5785 MHz
	27 V/m: 385 MHz
Power frequency magnetic fields IEC 61000-4-8	28 V/m: 450, 810, 870, 930, 1720, 1845, 1970, 2450 MHz
	30 A/m

FCC Statement (US)

This device complies with Part 15 of the FCC Rules. Operation is subject to the following two conditions:

- This device may not cause harmful interference, and
- This device must accept any interference received, including interference that may cause undesired operation.

“Harmful interference” is defined by FCC as any emission, radiation or induction that endangers the functioning of a radio navigation service or of other safety services or seriously degrades, obstructs or repeatedly interrupts a radiocommunications service operating in accordance with FCC rules.

The Grantee is not responsible for any changes or modifications not expressly approved by the party responsible for compliance. Such modifications could void the user’s authority to operate the equipment.

Declaration of Conformity (UK)

Adherium (NZ) Ltd declares that this Hailie® sensor is in compliance with the essential requirements and other relevant provisions of UK MDR 2002 (Directive 93/42/EEC, as applicable).

Adherium (NZ) Ltd declares that the radio equipment type Hailie® sensor is in compliance with The Radio Equipment Regulations 2017 (Directive 2014/53/EU). The full text of the UK Declaration of Conformity is available at: www.adherium.com/UKDOC

UK CA

Contact Information

UK RP
Emergo Consulting (UK) Limited
c/o Cr360 – UL International
Compass House, Vision Park Histon
Cambridge CB24 9BZ
United Kingdom

Australian Sponsor
Adherium Ltd
Collins Square | Tower Four
Level 18, 727 Collins Street
Melbourne VIC 3008
Australia

Hailie® sensor is manufactured by:
Adherium (NZ) Ltd
63 Albert Street
Auckland 1010
New Zealand
support@hailie.com
www.hailie.com

Hailie® Sensor Product Manual
Part Number: ND0535
Version: 2
Issue Date: 17 March 2023

No part of this document may be reproduced or transmitted in any form or by any means, electronic, mechanical, photocopying, recording, or otherwise, without the prior written permission of Adherium (NZ) Ltd.

Product specifications may change without notice.

For patent and trade mark information, including third-party trademarks, refer to www.adherium.com/ip.

Symbicort and *Vannair* (budesonide/ formoterol fumerate dihydrate) are trademarks of the AstraZeneca group of companies.

© 2023 Adherium (NZ) Limited. All rights reserved.